

AXOLYTE Outdoor



Smith John	23
Smith Sarah	
Brown Adam	80
Rogers Angie	
Stevens Charlie	39
Stevens Clair	

OK

1	2	3	OK
ABC	DEF		
4	5	6	▲
GHI	JKL	MNO	
7	8	9	▼
PQRS	TUV	WXYZ	
*	0	C	📄
		#	

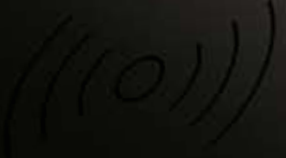

The AXOLUTE line has been enriched
to bring value even outside the building

AXOLUTE Outdoor





bticino

Steel

ppcivo

The AXOLUTE line has been enriched
to bring value even outside the building

AXOLUTE Outdoor





Smith John 23
Smith Sarah
Brown Adam 80
Rogers Angie
Stevens Charlie 39
Stevens Clair

OK

1 ☐	2 ABC	3 DEF	OK
4 GHI	5 JKL	6 MNO	▲
7 PQRS	8 TUV	9 WXYZ	▼
* ☎	0 └	# C	☒

((((0))))

bticino

Brass



Steel

bticino

AXOLUTE Outdoor

Steel finish for prestigious backgrounds



Hi-tech spirit and essential design combined to the elegance of steel
in the version conceived for the most modern backgrounds



A precise shape, with clean cut
and sharp lines, to bring even more
value to the most prestigious buildings

AXOLUTE Outdoor

Brass finish for valuable, classical environments



High technology and a smooth shaped design combined to the value of brass in the version conceived for the most classical backgrounds



A soft and elegant form, enriched by the use of brass, to give more value to prestigious buildings.

AXOLUTE Outdoor

A wide choice of features for a stylish, unique object



- The alphanumeric keyboard, provided of a blue led backlight, enables to find the resident as with mobile phones
 - They keys are capacitive: they are activated with a simple touch
 - The alphanumeric keyboard enables to call the resident directly by means of a numerical code
 - The electronic module is made with a reinforced glass front and follows the new trends of interior and exterior design
- Opening gates with the transponder key



■ Motorised video camera

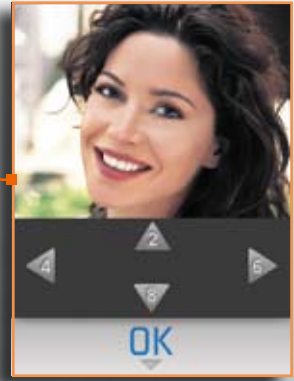

Image filmed by the video camera in the regulation phase

The informations provided by the display can be easily customized by programming with the supplied software



■ Default screen



■ Sample screen with street number plus other informations



■ Sample screen with customizable logo

■ Display of the resident address book



■ Informations on how to reach the resident called, by displaying a map

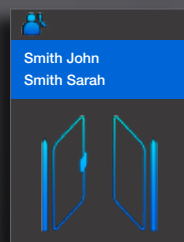
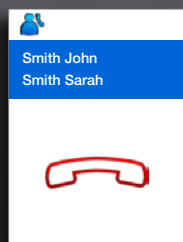
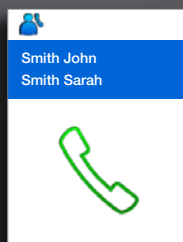

■ User-friendly interface. The icon display helps the user to understand the communication state

AXOLUTE Outdoor: the first native 2 WIRE and IP device...

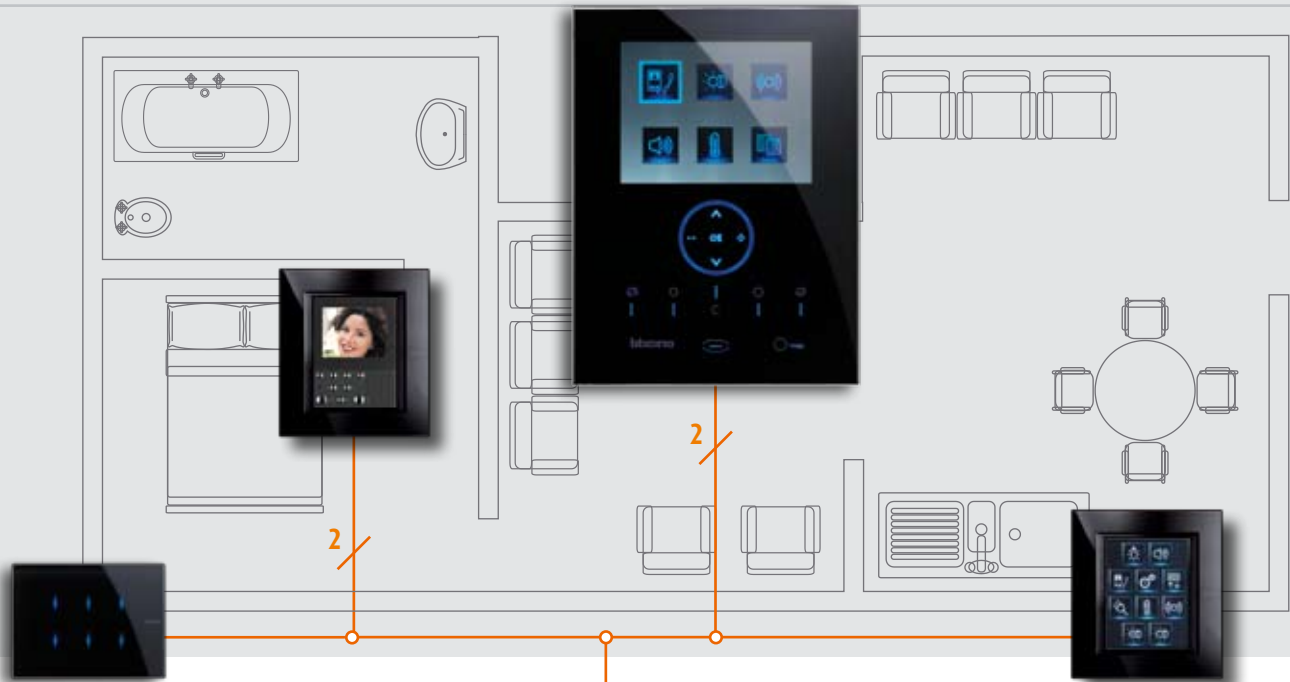

2 wires



All the advantages of the 2 wire system



...choose the technology that suites the most to the type of building

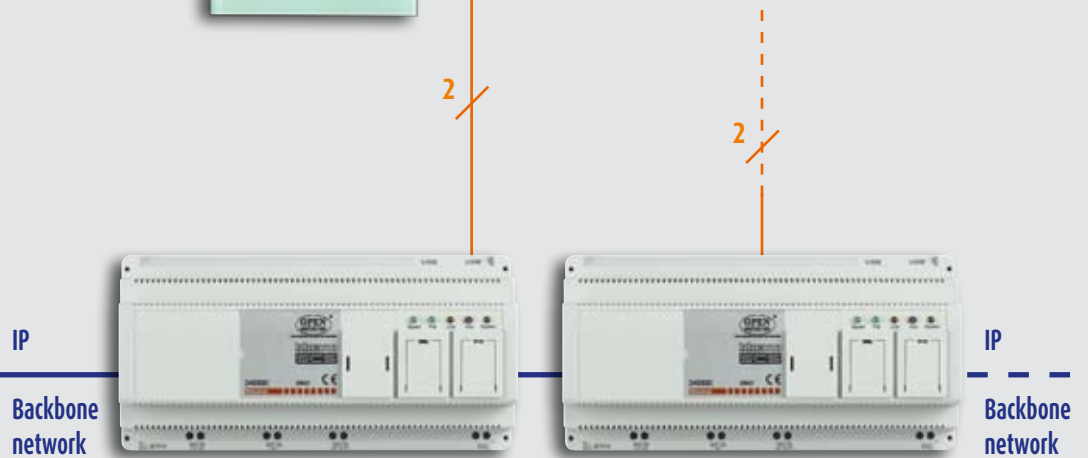
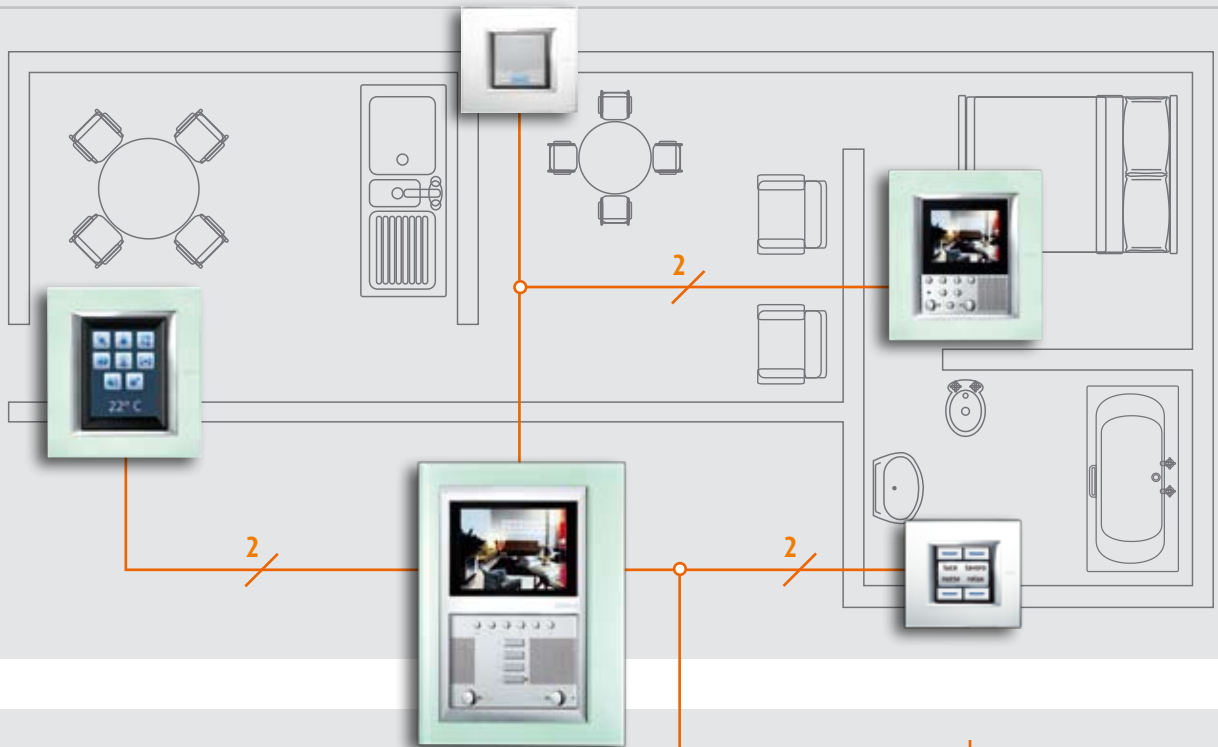

In order to use all the potential of the IP SYSTEM:
multichannel, extension over long distances,
unlimited number of 2 wire risers



AXOLUTE Outdoor: installation

Simple assembly

The strength of the installation is improved by the use of the steel tear proof flush mounted box. Installation in 3 module SFERA box is also possible.

Protection index : IP54
Protection index against mechanical impact : IK07



Minimum projection from the wall

For steel finish: 11 mm
For brass finish: 13,5 mm

Body flush fit in the wall

The frames are set with a special key which permits an anti-housebreaking resistant fit and an easy maintenance.



AXOLUTE Outdoor: configuration

Configuration suited to all needs

The device can be configured in three different ways:

- by physical insertion of the configurators in their appropriate seat
- directly from the button panel from the installer menu (password protected function)
- by means of a PC, using the software provided with the electronic module

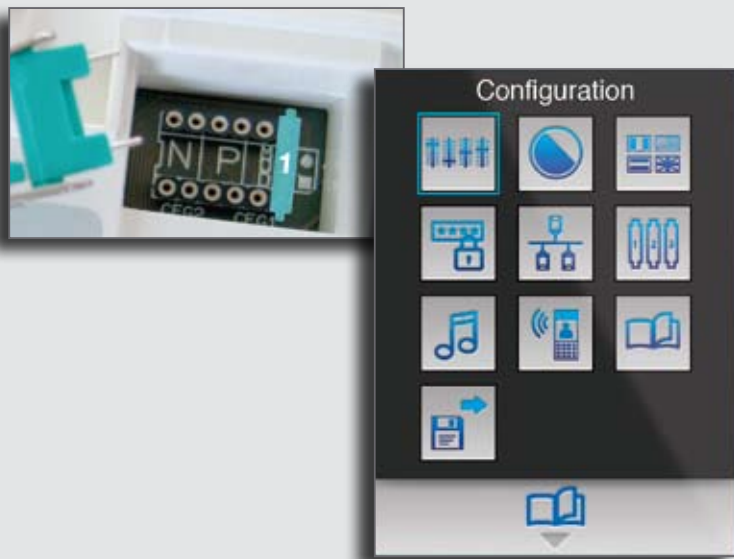

The software enables an easy configuration of the device: a high level of customization is possible and advanced functions can be set, including managing the residents' index of names and programming the transponder keys for access control.

USB Connection

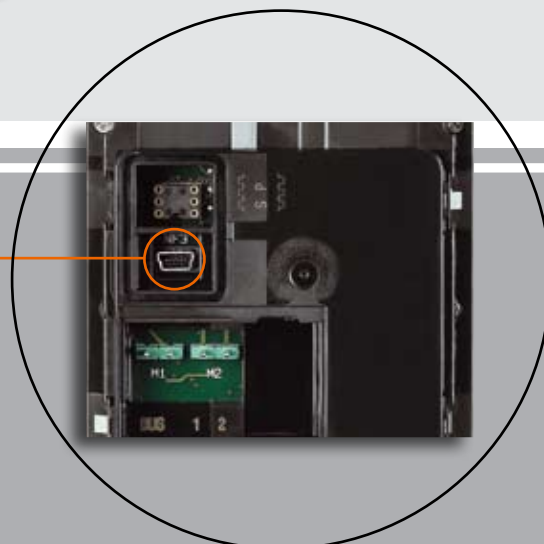

Details of the electronic module's rear

AXOLUTE Outdoor: catalogue

Flush mounted box and electronic module

ITEM

- 339313** Steel tear proof flush mounted box - 3 modules
- 349140** Electronic module including: speaker phone module, motorised camera and colour display. A proximity reader is integrated for access control functions by means of electronic keys. Programming and configuration software included.



339313



349140

Finishing frame

ITEM

- 339213** 3 module frame + supporting frame in steel finish. Anti-housebreaking resistant safety key for assembly and disassembly provided.
- 339223** 3 module frame + supporting frame in brass finish. Anti-housebreaking resistant safety key for assembly and disassembly provided.



339213



339223

Dimensions

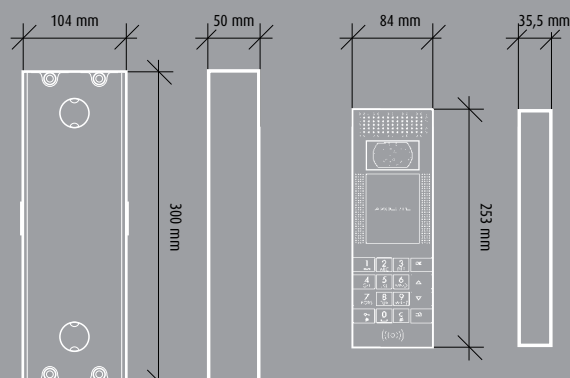

Flush mounted box

Electronic module



348402

Transponder keys programmer

ITEM

348402 Transponder key programmer



348200



348201



348202



348203



348204



348205



348206

Transponder keys

ITEM

348200 Black transponder key

348201 Red transponder key

348202 Green transponder key

348203 Blue transponder key

348204 Orange transponder key

348205 Gray transponder key

348206 Yellow transponder key

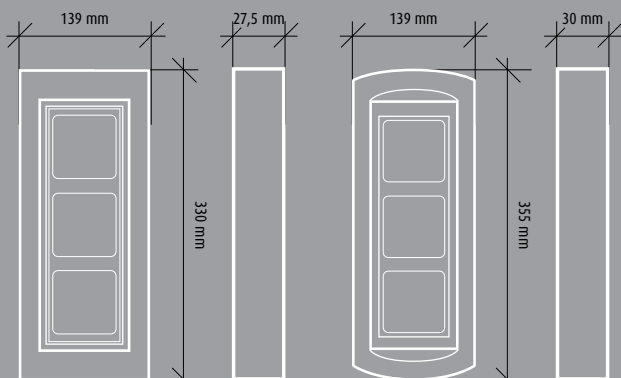

Steel frame + supporting frame
Projection from wall: 11 mm

Brass frame + supporting frame
Projection from wall: 13.5 mm



BTicino SpA
Via Messina, 38
20154 Milano - Italia
www.bticino.com
www.bticino.it



BTicino S.p.A. reserves at any time the right to modify the contents of this booklet and to communicate in any form and modality, the changes brought to the same.

AX080DV/GB
Edition 09/2008